

Commercial Building Electrical Systems - Lighting Systems

Lighting Terminology

Lumens

Lumens are a measure of the brightness of a bulb. One lumen is equal to the light of one candle from one foot away.



Watt

Watts measure the amount of energy a bulb uses to produce light. Wattage is the amount of power required to operate an electrical appliance or device.

Kelvins

The color temperature, measured in Kelvins, refers to a lamp's emitted color.

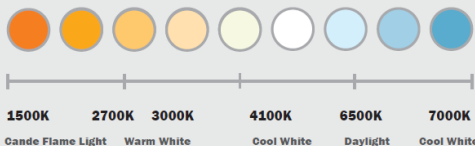

Brand

The manufacturer.

LED lighting facts
A Program of the U.S. DOE

Light Output (Lumens)	452
Watts	6.1
Lumens per Watt (Efficacy)	74
Color Accuracy Color Rendering Index (CRI)	83
Light Color Correlated Color Temperature (CCT)	2950 (Warm White)

2700K 3000K 4500K 6500K

Lighting Facts

Per Bulb

Brightness	700 lumens
Estimated Yearly Energy Cost	\$1.08
Based on 3 hrs/day, 11¢/kWh Cost depends on rates and use	
Life	27.4 years
Based on 3 hrs/day	
Light Appearance	6000 K
Warm ————— Cool	
Energy Used	9 watts

Life

Life of the bulb, based on 3 hours a day work.

Efficacy

Lumens per Watt measures efficiency. The higher the number, the more efficient the product.

CRI

The Color Rendering Index (CRI) is a rating scale up to a 100 that rates how accurately a light source can express true color in comparison with an ideal or natural light source.

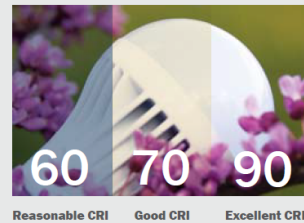

Yearly Cost

Estimated Yearly Energy Cost based on 3 hrs/day 11¢/kWh (cost depends on rates and use)

Lamp Types

- Light Emitting Diode - LED
- Fluorescent - FL
- Compact Fluorescent (CFL)
- Incandescent (INC)
- Halogens
- High Intensity Discharge (HID)
 - High Pressure Sodium (HPS)
 - Metal Halide (MH)
 - Mercury Vapor (MV)
 - Low Pressure Sodium

Watts vs. Lumens

- 40W bulb: at least 450 lumens
- 60W bulb: at least 800 lumens
- 75W bulb: at least 1,100 lumens
- 100W bulb: at least 1,500 lumens

Fact: The more lumens of light you get per watt of electricity, the more efficient the bulb is.

A 10W LED can easily outshine a 12W competitor if it converts watts to lumens more efficiently.

Efficiency = lumens / watts

Light Emitting Diode – LED

<https://www.youtube.com/watch?v=oPYrldvk2is>

Energy-efficient LED bulbs are available in a variety of shapes and sizes. LEDs deliver quality light across a broad spectrum of color temperatures from warm ambient light to the bright white look of daylight, to suit any indoor or outdoor application. LED light bulbs, or light emitting diodes, are low heat, long lasting, energy efficient lighting alternatives for your home or business. The availability and selection of LED light bulbs has expanded greatly. No longer are LEDs just for exit signs. LEDs are available in almost all base and shape configurations.

A Group: A15, A19, A21, and A25



From top left to bottom right: A19 LED filament bulbs in ceiling fan fixture, A21 LED bulbs in bedroom lamps, A19 gold-tint LED filament bulb in porch light fixture, A19 LED fireworks bulbs in string lights

Standard/arbitrary (A) bulbs are the most widely used and thought of when it comes to household lighting. These bulbs work well for a variety of applications, such as ceiling lights, lamps, vanity lights, kitchen lights, closet lights, porch light fixtures, and so many more.

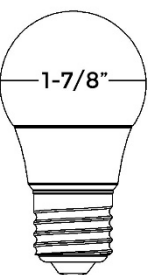
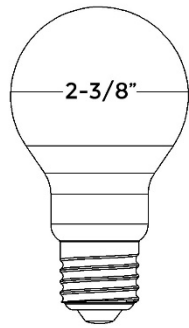
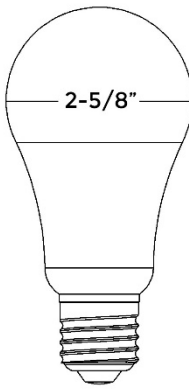
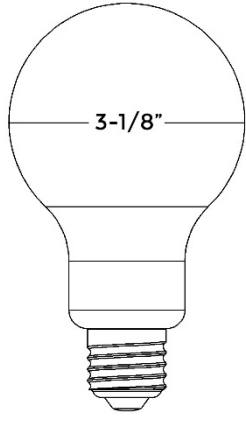
Numbers in each code refer to the bulb's diameter in one-eighths of an inch.				Most common base types:  E26/E27 medium screw base
 1-7/8" A15	 2-3/8" A19	 2-5/8" A21	 3-1/8" A25	

G group: G11, G14, G16/G50, G60, G25/G80, G30



From top left to bottom right: G14 LED bulbs in ceiling light fixture, G30 LED bulbs in bathroom vanity, G30 LED filament bulb in porch light fixture, G16 gold-tint LED filament bulbs in ceiling light fixture

Globe (G) bulbs have a full, round shape and are available in various sizes. They can be used for many applications throughout the home, such as foyer lights, kitchen lights, chandeliers, and ornamental fixtures. The most common type is the large G30 bulb, which is used in bathroom and makeup vanities.

Depending on the bulb, numbers in each code can refer to the bulb's diameter in one-eighths of an inch or in millimeters.

G11
G14
G16/G50
G60
G80/G25
G30

Most common base types:

E26/E27 medium screw base

E12 candelabra

B and C groups: B10, C7, C9, C15, CA10

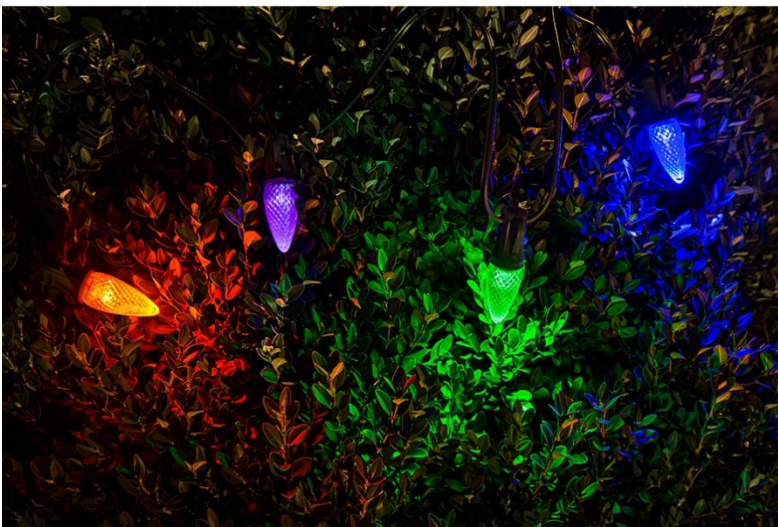

From top left to bottom right: B10 LED bulbs in wall sconce, CA10 LED bulbs in chandelier, C9 LED bulbs in Christmas light strings, C7 LED bulb in night light

All of the bulbs in these groups resemble the shape of a candle flame and are often referred to as candle bulbs. Conical (C) bulbs are shaped like a cone. Conical angular (CA) bulbs are shaped like a cone but have a bent tip. Blunt-tip (B) bulbs are very similar to C-type bulbs but have more of a torpedo or bullet shape. These bulbs can be used in chandeliers, wall sconces, pendant lights, night lights, decorative light strands, holiday light strands, and other decorative home lighting applications.

<p>Numbers in each code refer to the bulb's diameter in one-eighths of an inch.</p>		<p>Most common base types:</p> <p>E12 candelabra</p> <p>E17</p> <p>E26/E27 medium screw base</p>
---	--	---

BR group: BR20/R20, BR30, BR40



From top left to bottom right: BR20/R20 LED bulbs in bedroom can lights, BR40 LED bulbs in living room can lights, BR30 LED bulbs in home theater can lights, BR40 LED bulbs in kitchen can lights

BR stands for bulged reflector. Traditionally, the inside surface of an incandescent BR bulb is covered in reflector material that is used to gather and cast a wide beam of light away from the bulb. LED BR bulbs don't require the reflector material. These bulbs can have a frosted, clear, or patterned dome-shaped lens that diffuses light and provides a gradual fade into nonilluminated areas. BR bulbs also produce less shadows when compared to PAR bulbs. They're a bit longer than PAR bulbs and tend to protrude from light housings but are used in similar applications, such as track lights, recessed lights, display lights, or can lights.

BR20 bulbs are often referred to as R20 but have the same characteristics of other BR bulb types. The R stands for reflector.

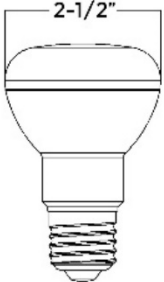
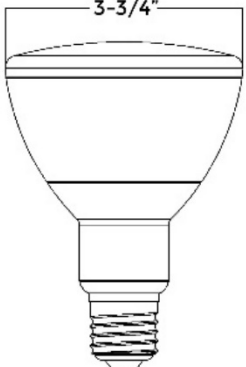
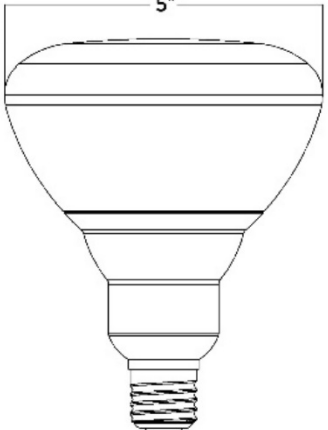
<p>Numbers in each code refer to the bulb's diameter in one-eighths of an inch.</p>			<p>Most common base types:</p>  <p>E26/E27 medium screw base</p>
 <p>2-1/2"</p> <p>BR20/R20</p>	 <p>3-3/4"</p> <p>BR30</p>	 <p>5"</p> <p>BR40</p>	



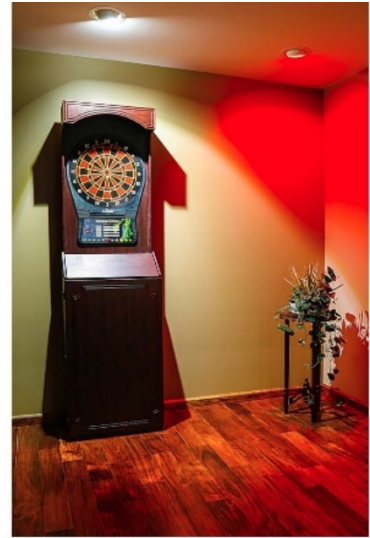

PAR group: PAR16, PAR20, PAR30, PAR36/AR111, PAR38



From top left to bottom right: PAR16 LED bulbs in ceiling fan fixture, PAR30 LED bulbs in recessed soffit light fixtures, PAR16 LED bulbs in eyeball light fixtures, PAR38 LED bulbs in garage security light, PAR38 LED bulb in kitchen can light

PAR stands for parabolic aluminized reflector. In traditional incandescent PAR bulbs, a U-shaped reflector is used to maximize brightness and direct light through the front of the bulb in a narrow spot beam or wide flood beam pattern. Oftentimes, LED PAR bulbs will not have a reflector but will still deliver the hard-edged lighting (less of a gradual fade than BR bulbs) that is typical of incandescent PAR bulbs. These bulbs have a shorter body than BR bulbs and usually install flush with ceilings or fixtures, which reduces glare. They're commonly found in outdoor emergency light, spot light, or floodlight fixtures but can also be used indoors for track lights, recessed lights, display lights, or can lights.

PAR36 bulbs are sometimes referred to as aluminized reflector (AR111) bulbs. They're shaped differently than other PAR bulbs in that they have a fairly low-profile body. The insides of these bulbs are coated in a reflector material or consist of faceted reflectors. LED bulbs don't require the reflectors but often use them anyway. Similarly, to other PAR bulbs, they emit focused, hard-edged lighting in a spot or flood beam pattern. These bulbs run on low-voltage AC/DC wiring systems and are great for outdoor and landscape lighting applications such as architectural lights, driveway lights, path lights, gazebo lights, and paver lights that have weatherproof housings.

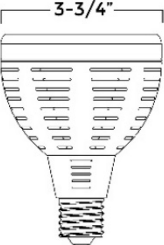
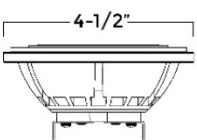
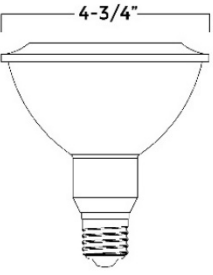
<p>Numbers in each code refer to the bulb's diameter in one-eighths of an inch. The numbers after "AR" refer to the bulb's diameter in millimeters.</p>					<p>Most common base types:</p>  <p>E26/E27 medium screw base</p>  <p>G53 screw pin</p>
 <p>PAR16</p>	 <p>PAR20</p>	 <p>PAR30</p>	 <p>PAR36/AR111</p>	 <p>PAR38</p>	

MR group: MR11 and MR16



From top left to bottom right: MR11 LED bulbs in bollard lights, MR16 LED bulbs in ceiling fan fixture, MR11 LED bulbs in path lights, MR16 LED bulbs in kitchen track light fixture

Multifaceted reflector (MR) bulbs are small in size with a reflective, faceted interior. The facets create a concentrated beam of light that can be displayed in a narrow spot or wide flood beam pattern. Because of the directional light they provide, MR LED bulbs don't require the facets but often still have them. These bulbs are available in a variety of colors and can be used for many applications, including track lighting, recessed lighting, desk lights, and display case lighting. Many MR bulbs operate on low-voltage wiring systems, which makes them great for outdoor and landscape applications such as driveway lights, path lights, gazebo lights, paver lights, and malibu lights that have weatherproof housings.

Numbers in each code refer to the bulb's diameter in one-eighths of an inch.

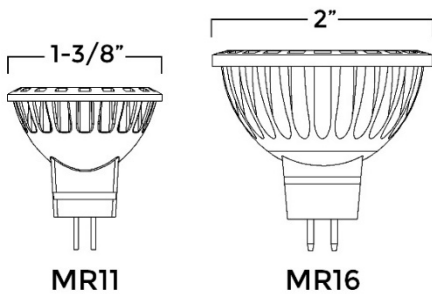

Most common base types



GX5.3 bi-pin



GZ4 bi-pin



GU10 bi-pin

T group: T7, T8, T10, T14



From top left to bottom right: T7 LED bulb in wall sconce, T14 LED bulbs in bathroom vanity light fixture, T8 LED bulbs in garage tube light fixture, T10 LED bulb in freezer, T8 LED bulb in basement tube light fixture

Tubular (T) bulbs come in a variety of lengths and widths. Depending on their size, these bulbs can be used in applications ranging from chandeliers, wall sconces, and pendant lights to basement and garage troffer light fixtures.

Numbers in each code refer to the bulb's diameter in one-eighths of an inch.

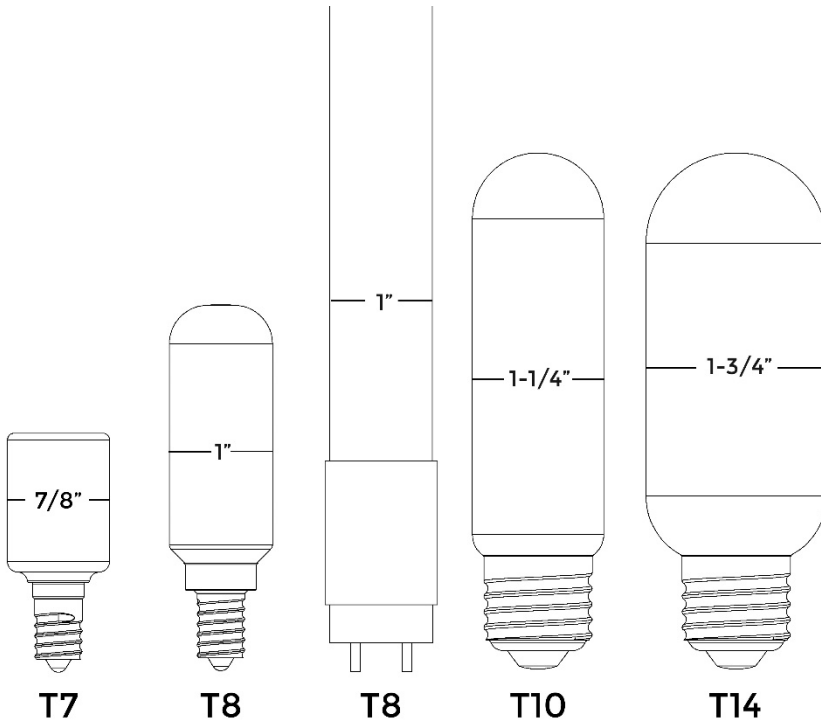

Most common base types:



E26/E27 medium screw base



E12 candelabra



E17



BA15D bayonet



G13 bi-pin

Types of Light Fixtures



Lensed Fluorescent Troffer

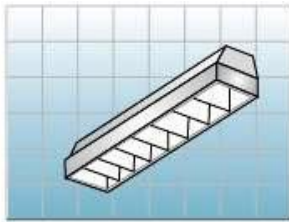

Parabolic Louver Fluorescent Troffer, 1x4 Baffle

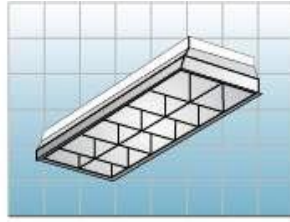

Parabolic Louver Fluorescent Troffer, 2x4 Louver



Recessed Round Downlight



Recessed Square Downlight



Recessed Linear Wall-washer



Chalkboard or Whiteboard Luminaire



Recessed Accent Light (MR-16)



Recessed Accent Light (MH PAR)



Track Lighting (Incandescent)



Track Lighting (Fluorescent)



Task Lighting, Fixed and Furniture Integrated



Portable Task Lighting



Decorative Pendant Downward Light

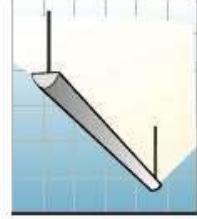

Suspended Linear Fluorescent Luminaire

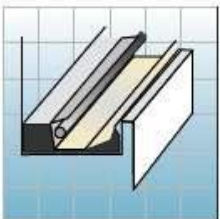

Cove-mounted Uplighting



Portable Torchiere Uplight



Open HID High-bay Luminaire Glass or Plastic Reflector

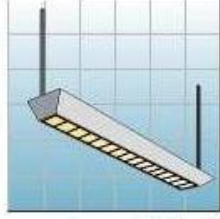

Suspended Direct-Indirect Fluorescent Luminaire (mostly up)

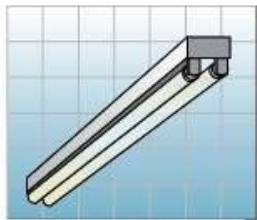

Open Fluorescent Luminaire, Striplight

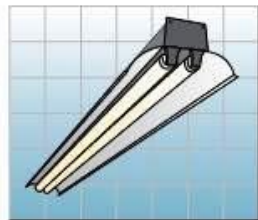

Open Fluorescent Luminaire, Refl. Industrial



Lensed HID "Low-bay" Luminaire

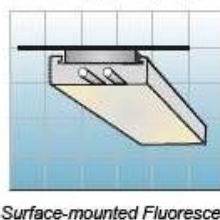

Surface-mounted Fluorescent "Wraparound"

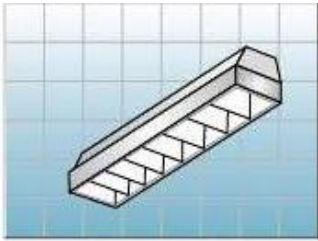

Parabolic Louver Fluorescent Troffer for Critical VDT Applications

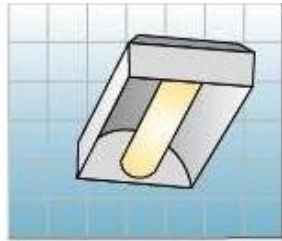

Recessed "Indirect" Luminaire



Open HID High-bay (Metal Reflector) Luminaire



Recessed Round Wall-washers



Recessed Wall Slots

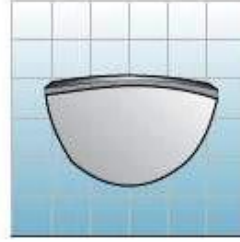

Decorative Wall Sconce



Track Lighting (Metal Halide)

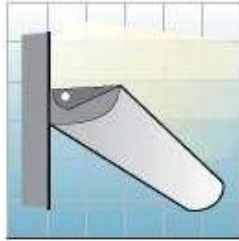

Wall-mounted Uplighting



Decorative Direct-Indirect Pendant



Decorative Indirect Pendants



Decorative Luminaire, Pendant



Decorative Luminaire, Sconce

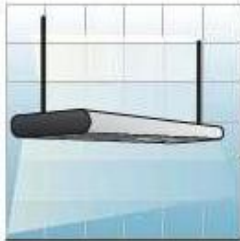

Suspended Direct-Indirect Fluorescent Luminaire (mostly down)



Lensed CF "Low-bay" Luminaire



Functional Wall Sconce

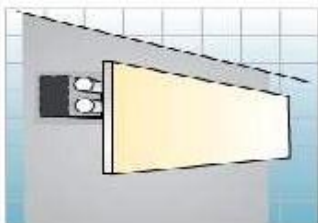

Wall-mounted Valance

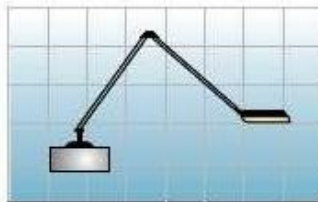

Typical Compact Fluorescent Task Light

Installation



Cove-mounted Up-lighting

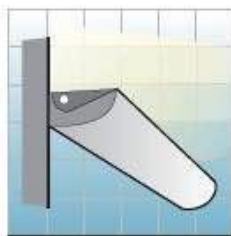

Wall-mounted Up-lighting

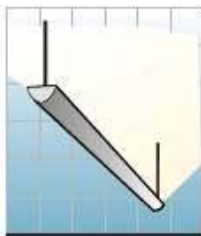

Suspended Linear Fluorescent Luminaire



Recessed Round Downlight



Open HID High-bay (Metal Reflector) Luminaire



Recessed Round Wall-washers



Decorative Pendant Downward Light



Portable Task Lighting



Track Lighting (Metal Halide)



Track Lighting (Incandescent)



Functional Wall Sconce

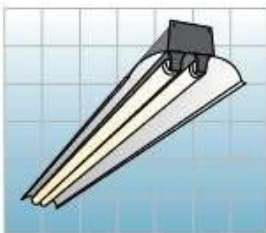

Open Fluorescent Luminaire, Ref. Industrial



Portable Torchiere Up-light



Task Lighting, Fixed and Furniture Integrated

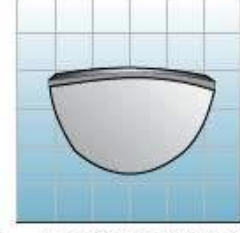

Decorative Wall Sconce

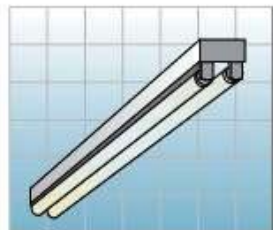

Open Fluorescent Luminaire, Striplight

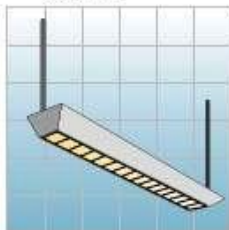

Suspended Direct-Indirect Fluorescent Luminaire (mostly up)



Open HID High-bay Luminaire, Glass or Plastic Reflector

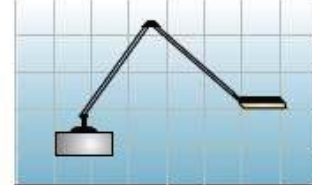

Typical Compact Fluorescent Task Light





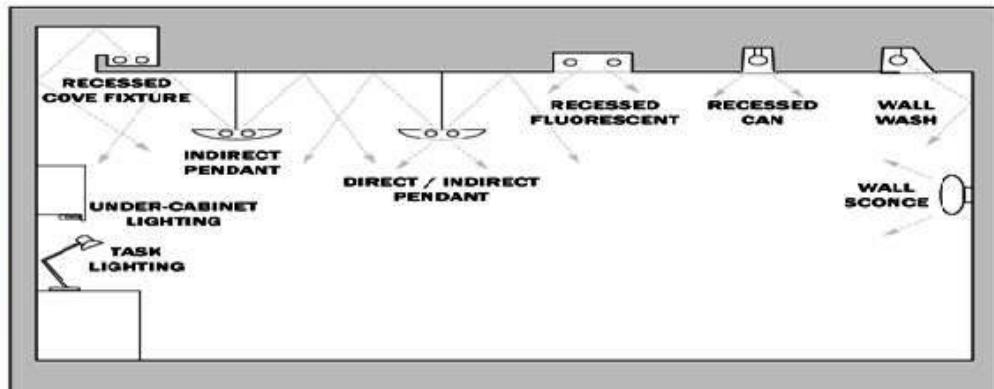











LED Exit Sign



LIGHTING SYMBOLS:

ALL SYMBOLS MAY NOT APPLY TO THIS PROJECT.

	• 1x4 LED LIGHT.	\$	• SINGLE POLE TOGGLE SWITCH MOUNTED AT 48" A.F.F. TO CENTER, UNO. HUBBELL #1221W, 20A, 120/277V.
	• 1X4 NIGHT LED LIGHT.		
	• 2x4 LED LIGHT.	\$D	• SINGLE POLE DIMMER SWITCH MOUNTED AT 48" A.F.F. TO CENTER, UNO. LEVITON #81000-W, 20A, 120V, 1000W, UNO.
	• 2X4 NIGHT LED LIGHT.		
	• 8'0" LINEAR LED NIGHT LIGHT.	\$3	• THREE WAY TOGGLE SWITCH MOUNTED AT 48" A.F.F. TO CENTER, UNO. HUBBELL #1223W, 20A, 120/277V
	• 4'0" LINEAR NIGHT LED LIGHT.		
	• 8'0" LINEAR LED LIGHT.	⚡	• HORN AND SPEAKER - REFER TO E2 & ETD SYMBOLS LISTS FOR FURTHER INFORMATION.
	• 4'0" LINEAR LED LIGHT.	NL	• NIGHT LIGHT WIRED TO BE UNSWITCHED FIXTURE.
	• WALL MOUNTED LIGHTING.	EM	• EMERGENCY WIRED TO BE UNSWITCHED FIXTURE, UNO.
	• RECESSED LED DOWN LIGHT.	\$M	• MOTION SENSOR WALL SWITCH-MAESTRO MODEL #MS-VPS6M2-DV-WH MOUNTED AT 48" A.F.F. TO CENTER OR AS NOTED.
	• EXTERIOR WALL MOUNTED FIXTURE.	(M)	• CEILING MOTION SENSOR - SENSOR SWITCH MODEL #CMR-PDT9-W, LINE VOLTAGE
	• EXIT SIGNS (PENDANT MOUNTED)	□	• 2x2 LED LIGHT
	• EXIT SIGNS (WALL / BULKHEAD MOUNTED)	◼	• 2x2 NIGHT LED LIGHT
	• CEILING OR WALL 2-HEAD EMERGENCY FIXTURE		

ELECTRICAL GENERAL NOTES:

1. ALL LED AND/OR FLUORESCENT LAMPS NOT INCLUDED WITH FIXTURES ARE FURNISHED BY THE GENERAL CONTRACTOR THROUGH GRAYBAR.
2. PROVIDE FIXTURE SAFETY CHAINS WHERE REQUIRED.
3. ALL LAY-IN FIXTURES SHALL BE FURNISHED WITH "FIXTURE SUPPORT CLIPS" PER NEC SECTION 410.
4. OFFSET LIGHT FIXTURES AS NEEDED TO CLEAR STRUCTURAL BRIDGING ACROSS STORE.
5. ALL LIGHT SWITCHES SHALL BE LOCATED AS CLOSE AS POSSIBLE TO ADJACENT DOOR FRAMES AT A.D.A. HEIGHTS. COORDINATE LOCATIONS WITH ALL FIXTURES/EQUIPMENT.
6. ALL LIGHTING SHALL BE CIRCUITED AS SHOWN TO ALLOW MULTI-LEVEL SWITCHING FOR ENERGY MANAGEMENT CONTROL, SEE SHEET EM2.
7. CONDUIT AND PIPING SHALL BE ROUTED PARALLEL WITH WALLS IN MAIN SALES AND RECEIVING. RUNS SHALL BE GROUPED TOGETHER WHERE PRACTICAL & HOLD AS HIGH AS POSSIBLE AND SUSPEND TIGHT TO THE TOP CORD OF JOIST.
8. PROVIDE ZERO DEGREE BALLASTS FOR FIXTURES LOCATED OUTSIDE.
9. ALL ELECTRICAL CONDUITS/WIRING MUST RUN OVERHEAD (UNO) UNLESS REQUIRED TO RUN UNDERGROUND. ANY EXCEPTIONS MUST BE APPROVED BY PETSMART CONSTRUCTION MANAGER.
10. SNAP SWITCHES THAT ARE GROUPED OR GANGED IN AN ENCLOSURE WITH OTHER SNAP SWITCHES OR SIMILAR DEVICES THAT THE VOLTAGE BETWEEN THE ADJACENT DEVICES EXCEEDS 300 VOLTS, MUST HAVE A PERMANENT BARRIER INSTALLED BETWEEN THE ADJACENT DEVICES PER THE N.E.C.
11. GENERAL CONTRACTORS SHALL CONTACT F.E. MORAN INC. ALARM FOR NATIONAL ACCOUNT BID PRICING ON FIRE AND BURGLAR ALARM SYSTEMS - SEE SPECIFICATIONS.
12. PROVIDE (2) PULL STRINGS IN EACH EMPTY CONDUIT FOR DATA & PHONE BOXES.
13. REFER TO "EM" SHEETS FOR SENSOR MOUNTING.
14. SEE ARCHITECTURAL ELEVATION DRAWINGS FOR EXACT PLACEMENT OF OUTLETS.
15. E.C. TO VERIFY EXACT CONDUIT SIZE PRIOR TO ROUGH-IN OF BOXES FOR PHONE AND DATA.
16. WHERE CONDUITS, DEVICE BOXES, ETC... ARE SURFACE MOUNTED, SEAL ALL PENETRATIONS WITH SIKKA, SIKAFLEX 1A POLYURETHANE SEALANT.
17. NOT USED.
18. SEE SHEET #E0.1 FOR ONE LINE DIAGRAM KEYED NOTES.
19. PROVIDE CONDUIT FOR LOW VOLTAGE WIRING WHEN REQUIRED BY CODE. TERMINATE PHONE & DATA WIRING AT PETSMART SERVER LOCATION.
20. ALARM PACKAGE: THE ALARM PACKAGE WILL REQUIRE AN AVERAGE OF 15 CONDUIT DROPS WITH BOXES, AND 35 BACK BOXES (ONLY) FOR CEILING MOUNTED DEVICES - THIS IS SUBJECT TO CHANGE BASED ON LOCAL REQUIREMENTS AND FINAL STORE DESIGN. ALL CEILING MOUNTED ALARM & INTRUSION DEVICES WILL REQUIRE A BACK BOX PROVIDED BY THE EC. ANY QUESTIONS, CONTACT NATIONAL ACCOUNT VENDOR - F.E. MORAN, INC. ALARM. (866) 472-6450 - SEE ARCHITECTURAL DRAWING F2.0 PRODUCT SCHEDULE.

LIGHT FIXTURE SCHEDULE

TYPE	MANUFAC.	CATALOG #	VOLT.	LAMP TYPE	WATTS	REMARKS
A08	COOPER	CORELITE RCL-WL-2L35-1D-UNV-SU-JB-8STD-W	MVOLT	LED	84	6.4" WD X 81" LONG LED LINEAR LIGHT FIXTURE, THREE-SIDED FROSTED PRISMATIC LENS. SEE NOTE 2.4.
A32	COOPER	CORELITE RCL-WL-2L35-1D-UNV-SU-JB-32STD-W	MVOLT	LED	336	6.4" WD X 92" LONG LED LINEAR LIGHT FIXTURE, THREE-SIDED FROSTED PRISMATIC LENS. SEE NOTE 2.4.
A52	COOPER	CORELITE RCL-WL-2L35-1D-UNV-SU-JB-52STD-W	MVOLT	LED	546	6.4" WD X 120" LONG LED LINEAR LIGHT FIXTURE, THREE-SIDED FROSTED PRISMATIC LENS. SEE NOTE 2.4.
A84	COOPER	CORELITE RCL-WL-2L35-1D-UNV-SU-JB-84STD-W	MVOLT	LED	882	6.4" WD X 120" LONG LED LINEAR LIGHT FIXTURE, THREE-SIDED FROSTED PRISMATIC LENS. SEE NOTE 2.4.
A92	COOPER	CORELITE RCL-WL-2L35-1D-UNV-SU-JB-92STD-W	MVOLT	LED	966	6.4" WD X 92" LONG LED LINEAR LIGHT FIXTURE, THREE-SIDED FROSTED PRISMATIC LENS. SEE NOTE 2.4.
A120	COOPER	CORELITE RCL-WL-2L35-1D-UNV-SU-JB-120STD-W	MVOLT	LED	1260	6.4" WD X 120" LONG LED LINEAR LIGHT FIXTURE, THREE-SIDED FROSTED PRISMATIC LENS. SEE NOTE 2.4.
A132	COOPER	CORELITE RCL-WL-2L35-1D-UNV-SU-JB-132STD-W	MVOLT	LED	1386	6.4" WD X 132" LONG LED LINEAR LIGHT FIXTURE, THREE-SIDED FROSTED PRISMATIC LENS. SEE NOTE 2.4.
BA	LITHONIA	2GTL-2-40L-LP835	277	LED	40	2X 2" LENSED LED LIGHT TROFFER
BC	LITHONIA	2GTL-2-20L-LP835	277	LED	20	2X 2" LENSED LED LIGHT TROFFER
EM	LITHONIA	ELMLT-W-LP06VS-LTP	277	LED	6	EMERGENCY BATTERY UNIT WITH 2- LAMP HEADS.
G	LITHONIA	CL2N-L46-5000LM-MDD-120-35K-80CRI-WH	277	LED	67	4" LENSED LED STRIP FIXTURE. REFER TO KEY NOTE 1 ON SHEET E0.1
H	JUNO	TRACKHEAD: TL261L-35K-S-WH-TIR-2-NFL TRACK: TL8WH TRACKHEAD DRIVER: TL601E-75	120	LED	12.6	TRACK MOUNTED ADJUSTABLE FIXTURE (CONIX II LED SPOT).
H1	JUNO	TRACKHEAD: TL261L-35K-N-WH-TIR-2-NFL TRACK: TL8WH TRACKHEAD DRIVER: TL601E-75	120	LED	12.6	MONOPOINT ADJUSTABLE FIXTURE (CONIX II LED SPOT).
L	LITHONIA	TWR1LED-1-40K-MVOLT	277	LED	33	LED WALL PACK AT 15" AFF. UNLESS NOTED OTHERWISE LAMP FACTORY INSTALLED.
M	LITHONIA	LDN6-35/15-LO6AR-277	277	LED	26	7" LED DOWN LIGHT
S	LITHONIA	LQM-S-W-R-120/277-ELN	277	LED	1	EXIT SIGN WITH BATTERY PACK. SEE DETAIL 4/E1.0.
W	LITHONIA	ELM1272-R0-TD	277	LED	-	EMERGENCY BATTERY UNIT W/O LAMP HEADS TO PROVIDE BATTERY POWER FOR EXTERIOR REMOTE HEADS.
X	LITHONIA	ELA-T-6CS-WP-M12	277	(2) 5.4W LAMPS, FURNISHED W/FIXTURE	8	REMOTE LAMP HEADS FOR EXTERIOR EMERGENCY LIGHTING. CONTRACTOR SHALL PROVIDE MANUFACTURER RECOMMENDED WIRE SIZE BETWEEN BATTERY POWER PACK AND REMOTE HEADS FOR VOLTAGE DROP.

1. CONTRACTOR SHALL CONTACT LIGHTING DISTRIBUTOR, GRAYBAR ELECTRIC FOR ORDERING INFORMATION. THIS IS A REQUIRED VENDOR, SEE REQUIRED VENDOR LIST ON SHEET F2.0 FOR CONTACT INFORMATION.
2. SEE PLAN FOR LENGTH AND QUANTITY OF LINEAR FIXTURES PER ROW. (42-WATTS PER 4-FT LENGTH).
3. ELECTRICAL CONTRACTOR TO VERIFY ALL QUANTITIES OF LIGHT FIXTURES PRIOR TO ORDERING FIXTURES.
4. FURNISH FIXTURE WITH ALL NECESSARY JOINERS, CONNECTORS, ENDCAPS, ETC FOR A COMPLETE AND CONTINUOUS FIXTURE LENGTH RUN.

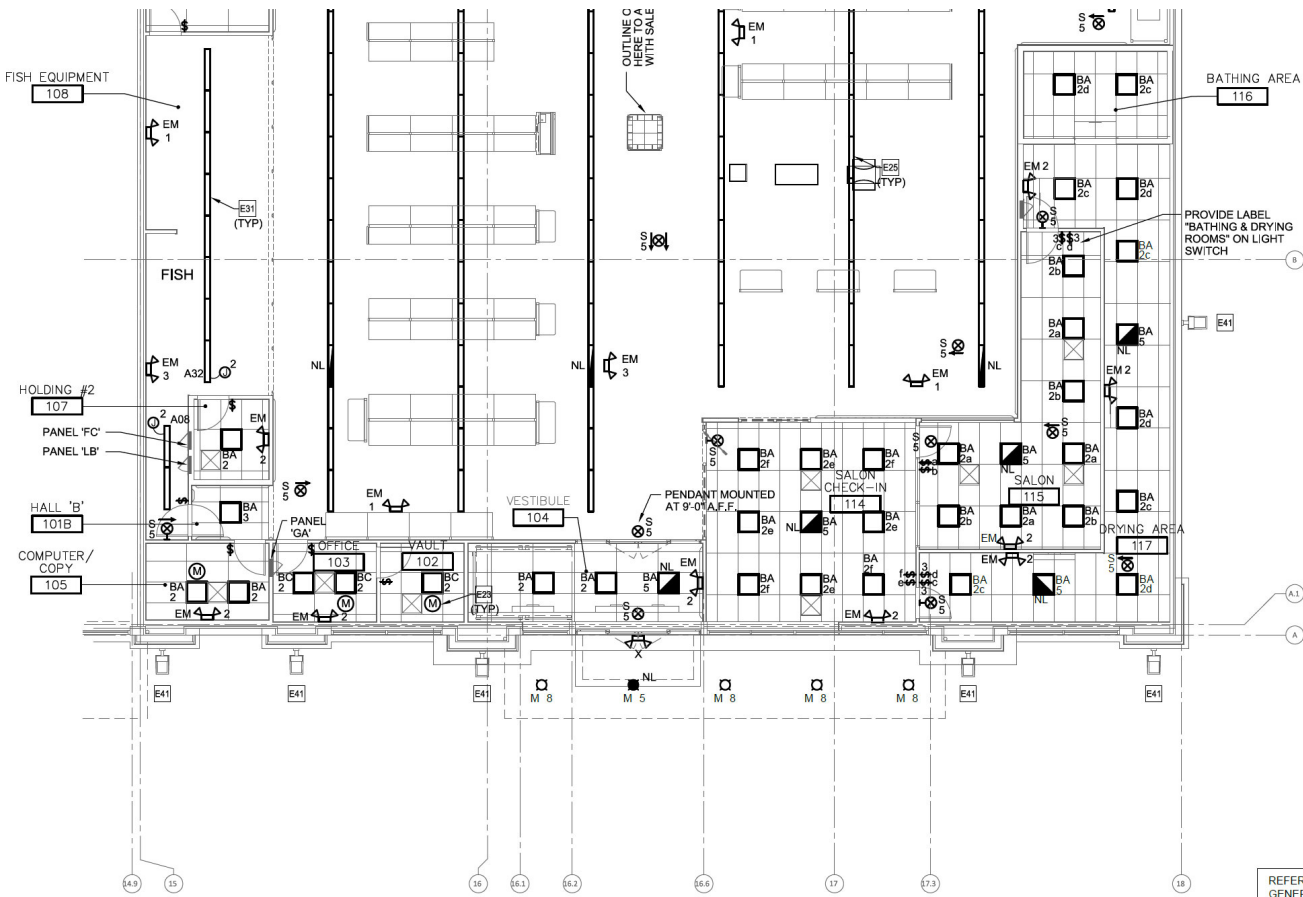

1 LIGHTING FLOOR PLAN
E1.0 SCALE 1/8" = 1'-0"



REFER TO SHEET E0.1 FOR GENERAL AND KEYED NOTES.

NOTE:
ALL LIGHTING ON THIS DRAWING IS CIRCUITED TO PANEL HA, UNLESS OTHERWISE NOTED.